

Eskimo[®]
ICE FISHING GEAR

2015-2016

PRODUCT CATALOG

ALL THE BENEFITS OF A FLIP WITH
TWICE THE ROOM!



EVO[™] CROSSOVER SHELTERS

CROSSOVER SHELTERS • POP-UP PORTABLES • FLIP-STYLE SHELTERS
POWER AUGERS • HAND AUGERS • REDNECK CHISELS
UTILITY HAULERS • CLOTHING • ACCESSORIES



**MORE ICE FISHERMEN
CHOOSE ESKIMO®**
THAN ANY OTHER BRAND



*PRO STAFF & MEMBERS OF
PRODUCT DEVELOPMENT TEAM*

OUR PROMISE

Right in the middle of the ice belt you'll find our hometown of Cumberland, Wisconsin – an island city literally surrounded by lakes. Like a lot of our neighbors, we have a love for the outdoors, especially ice fishing. From our customer service representatives, to our welders, to our engineers, fishing is in our DNA. It's not only a business for us, it's a way of life.

It's why we invented QuickFish™, the world's first pop-up portable ice shelter in 2005, giving ice anglers tons of room while remaining lightweight and easy to set up. Then we improved on that design by creating the FatFish™ – the first wide-bottom portable, designed to maximize fishable area. In 2014, we launched the HC40 High-Compression Propane Auger, with a custom-designed engine built to maximize the full potential of propane.

This season, we've created an entirely new category of ice fishing shelters. We're thrilled to introduce the EVO™ Crossover Shelter. Combining the spacious, lightweight comfort of pop-ups with the convenience of flip shelters, the EVO has the best features of both styles. Innovations on the ice—it's why more ice fishermen choose Eskimo than any other brand.

None of this would be possible without your trust and support. You have helped us become the number one supplier of ice fishing gear. For this, we thank you. We look forward to continuing to bring you the best ice fishing products on the market, and we can't wait to see you out on the ice this winter!

www.GetEskimo.com

ESKIMO® ICE SHELTERS

WHY ESKIMO?

THINGS TO CONSIDER
WHEN CHOOSING A SHELTER

THREAD WEIGHT / THREAD COUNT

ESKIMO VS. THE COMPETITION

When it comes to fabric there are two main factors to consider: thread weight (denier) and thread count. Together these two specifications determine your fabric performance. Competitors claim superiority based on thread weight, using a fabric made with heavier thread than ours (600 denier vs 300 denier). What they don't tell you is that we use a 59% higher thread count, which results in a much tighter weave. The durability and longevity of each fabric is comparable, however, Eskimo's IceTight fabric has an overall weight advantage of 19%! Who wants a heavier house to carry out onto the ice? Furthermore, IceTight fabric is coated, so it is completely wind and waterproof!



"300D POLYESTER"
IceTight material under
4x magnification

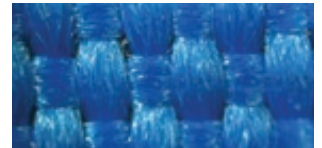

"600D POLYESTER"
Competitor material under
4x magnification

ICETIGHT™

ALL ESKIMO SHELTERS
FEATURE ICETIGHT™ FABRIC

59%
HIGHER
THREAD COUNT

TIGHTER
FABRIC WEAVE

19%
LESS OVERALL
FABRIC WEIGHT

INSULATION

ESKIMO IQ INSULATED QUILTED FABRIC

Insulated fabric provides warmth inside your shelter when you need it most. Eskimo insulated IQ™ fabric is made up of two layers of IceTight fabric that sandwich a layer of insulation, providing superior protection from the coldest conditions. Every Eskimo insulated shelter will keep you warm and dry, so you can fish even on the harshest of days. Look for the "i" at the end of applicable model numbers which indicate the insulated option.

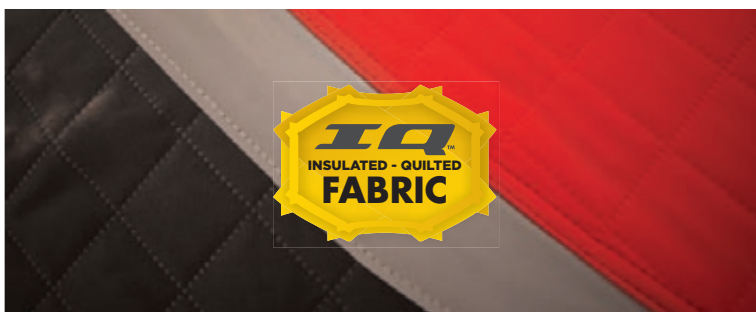

Eskimo's IQ fabric helps keep our team toasty warm, even in subzero temperatures."

JOSH CLAWSON
FISHADDICTIONS.COM



ESKIMO YKK ZIPPER



COMPETITOR ZIPPER

ALL ESKIMO SHELTERS FEATURE YKK® ZIPPERS

THE MOST RELIABLE ZIPPERS IN THE INDUSTRY

Eskimo doesn't cut corners when it comes to quality, and that philosophy extends to our choice of zipper. Zippers can be one of the most problematic features on an ice shelter. They work fine in the store, but once you get them into the harsh conditions out on the ice, they can freeze up, or even break. That's why we use only YKK branded zippers on all of our shelters. They are industry leading, rugged and reliable—things you have come to expect in an Eskimo ice shelter.



ICE ANCHORS

EASY TO USE, STRONG-HOLDING

Eskimo ice anchors are widely known and revered for their ease of use and tight-holding grip. These durable, steel-constructed anchors are self-tapping, featuring a sharp point, so they easily screw into the ice by hand. Large mitten grip handles allow you to secure your shelter without needless exposure to the elements.



CROSSOVER SHELTERS

EVO™

**ALL THE BENEFITS OF A FLIP
WITH TWICE THE ROOM**



The EVO is the most exciting new ice fishing product in years."

TROY PETERSON (MR. BLUEGILL)
FISHING GUIDE

CROSSOVER SHELTERS

The Eskimo® **EVO** is the first in a brand new category of shelters this year called crossovers. Crossover shelters offer the convenience of a flip-style shelter, with the room and comfort of a pop-up. Compared to similar sized flip-style shelters, the EVO offers more fishable area and functional space, providing plenty of maneuverability and room for your gear. The aerodynamic shape of the EVO cuts through the wind, allowing cold air to pass around the shelter and helping the venting system heat the shelter efficiently. The Eskimo EVO is truly a breakthrough for ice fishing.

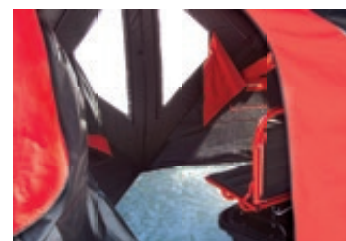

FEATURES:

- **MORE FISHABLE AREA** – The EVO gives you more fishable area than any comparable sled style shelter by utilizing fiberglass poles and hub technology.
- **LIGHTWEIGHT** – By replacing bulky metal poles with fiberglass poles, the EVO keeps weight to a minimum and makes it always easy to transport.
- **EXTRA LARGE WINDOWS** – The extra-large windows and coverings on the EVO allow you to control the amount of light being let into the shelter and give you visibility to all parts of the ice without having to leave your seat.
- **EXTRA HEIGHT OVER YOUR HOLES** – With the extra headroom where you need it, setting a hook inside your shack has never been easier.
- **OVERSIZED SIDE DOOR** – The EVO features an oversized side door, making it easy to move yourself and all your gear in and out of the shelter. The side position of the door allows you to enter and exit without having to step over your holes.
- **SELF-TAPPING ICE ANCHORS** – Easier to grip, and won't bend under pressure.
- **BETTER MATERIALS** – 300 Denier IceTight™ fabric with a 59% higher thread count than comparable shelters. This higher thread count results in a tighter weave, and offers the wind and watertight performance that Eskimo is known for, at an average weight savings of up to 19% over most competitors. Heavy-duty material is sewn over corner joints for reinforcement, and YKK® zippers are standard on every Eskimo shelter.
- **AERODYNAMIC** – The unique shape of the EVO allows the venting system to trap heat low in the shelter and force wind to flow smoothly around the outside—eliminating noisy flapping of the skin during windy days.



Eskimo has solved the issue of cramped space with flip shelters. It's the biggest flip shack I've ever seen, and I can't wait to use the extra space to help with landing some big fish."

SCOTTY BREWER
BREWER-AGRE OUTDOORS



	WEIGHT	FISHABLE AREA	INTERIOR VOLUME
EVO¹	52 lbs.	19.5 ft²	159 ft³
AVERAGE 1-PERSON FLIP SHELTER	55 lbs.	9.3 ft ²	78 ft ³
EVO²	85 lbs.	34.25 ft²	319 ft³
AVERAGE 2-PERSON FLIP SHELTER	88 lbs.	20 ft ²	148 ft ³

EVO

CROSSOVER SHELTERS

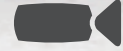

SEE THE EVO
IN ACTION AT
GETESKIMO.COM

EVO¹™

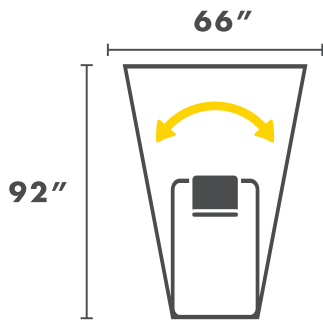

19.5 FT²
FISHABLE AREA



SPECIFICATIONS	22100
----------------	-------

Capacity	1 Person
Set-Up Size	66" x 92"
Fishable Area	19.5 sq. ft.
Height	65"
Collapsed Size	20.5" x 33.5" x 50"
Weight	52 lbs.
Warranty	1-Year Limited
Framework	Aluminum / Fiberglass
Ice Anchors	9
Ventilation	1
Windows	5
Doors	1
Gear Pockets	2
Fabric	300D IceTight™
Transport	Towable
Seating	Swivel Versa Seat
Seat Height	18"

**GREAT FOR
HOOK
SETS**



65" TALL OVER HOLES

EVO2 SETUP GUIDE

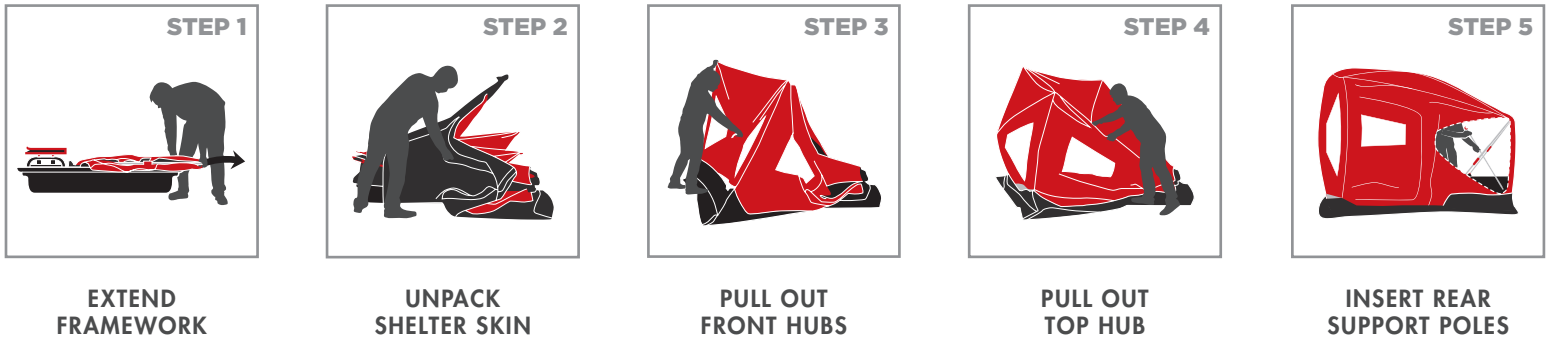

EXTEND FRAMEWORK

UNPACK SHELTER SKIN

PULL OUT FRONT HUBS

PULL OUT TOP HUB

INSERT REAR SUPPORT POLES

EVO2TM

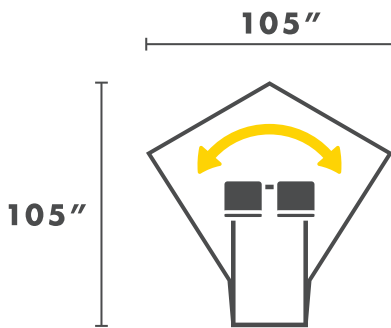

34.25 FT²
FISHABLE AREA



SPECIFICATIONS

22200

Capacity	2 People
Set-Up Size	105" x 105"
Fishable Area	34.25 sq. ft.
Height	75"
Collapsed Size	22.5" x 37.5" x 60"
Weight	85 lbs.
Warranty	1-Year Limited
Framework	Steel / Aluminum / Fiberglass
Ice Anchors	9
Ventilation	1
Windows	7
Doors	2
Gear Pockets	2
Fabric	300D IceTight™
Transport	Towable
Seating	(2) Swivel Versa Seats
Seat Height	19"



FATFISH

POP-UP SHELTERS

MORE FISHABLE AREA
THAN COMPARABLE STANDARD
POP-UP SHELTERS

Fish more comfortably with more people and more gear in the **FATFISH™**—the world’s first wide-bottom pop-up portable ice fishing shelter. The FatFish is designed to give you up to 80% more fishable area, while offering the same easy set-up and portability as the best-selling line of QuickFish™ shelters. The entire line of FatFish ice shelters are equipped with an all-metal ball and socket design and larger diameter poles, resulting in a stronger and more durable shelter.

“ I had 5 grown men, all our gear, a 3x3 table, and 2 jig holes with minimal issue. Best investment yet.”

CALEB B.
FATFISH 6120 CUSTOMER

FATFISH™ 767



SPECIFICATIONS

FF767

Capacity	2-3 People
Set-Up Size	76" x 76"
Elbow Room	81" x 81"
Fishable Area	40.0 sq. ft.
Height	67"
Collapsed Size	7.4" x 7.4" x 55"
Weight	23 lbs.
Warranty	1-Year Limited
Ice Anchors	6
Ventilation	2
Windows	6
Doors	2
Gear Pockets	2
Mesh Pockets	2
Fabric	300D IceTight™
Transport	Zipper Backpack

SPECIFICATIONS

FF949 / FF949i

Capacity	3-4 People
Set-Up Size	94" x 94"
Elbow Room	99" x 99"
Fishable Area	61.0 sq. ft.
Height	80"
Collapsed Size	7.5" x 7.5" x 65" / 8.25" x 8.25" x 65"
Weight	27 lbs. / 34 lbs.
Warranty	1-Year Limited
Ice Anchors	6
Ventilation	2
Windows	6
Doors	2
Gear Pockets	2
Mesh Pockets	2
Fabric	300D IceTight / Insulated IQ™
Transport	Zipper Backpack / Oversized Duffle Bag

FATFISH™ 949 FATFISH 949i





LARGER WINDOWS



ALL-METAL BALL AND SOCKET POWERHUB™



OVERSIZED POCKETS



IQ INSULATED FABRIC ("I" MODELS ONLY)



PORTABLE

FATFISH™ 6120
FATFISH™ 6120i



SEE THE
FATFISH 6120
IN ACTION AT
GETESKIMO.COM

SPECIFICATIONS

FF6120 / FF6120i

Capacity	5-7 People
Set-Up Size	115" x 115"
Elbow Room	122" x 122"
Fishable Area	80.0 sq. ft.
Height	78" / 76"
Collapsed Size	9" x 9" x 67" / 13" x 13" x 67"
Weight	36 lbs. / 52 lbs.
Warranty	1-Year Limited
Ice Anchors	9
Ventilation	2
Windows	10
Doors	2
Gear Pockets	2
Mesh Pockets	4
Fabric	300D IceTight / Insulated IQ
Transport	Zipper Backpack / Oversized Duffel Bag

SPECIFICATIONS

FF9416 / FF9416i

Capacity	7-9 People
Set-Up Size	94" x 167"
Elbow Room	99" x 172"
Fishable Area	109.0 sq. ft.
Height	80"
Collapsed Size	9.8" x 9.8" x 65" / 14" x 14" x 62"
Weight	41 lbs. / 55 lbs.
Warranty	1-Year Limited
Ice Anchors	9
Ventilation	2
Windows	10
Doors	2
Gear Pockets	4
Mesh Pockets	4
Fabric	300D IceTight / Insulated IQ
Transport	Zipper Backpack / Oversized Duffel Bag

FATFISH™ 9416
FATFISH™ 9416i



QUICKFISH POP-UP SHELTERS



THE ORIGINAL

As the innovator of the first pop-up portable ice fishing shelter, Eskimo® knows a thing or two about building the world's best on-the-go portables. Don't be fooled by imitation shelters with flimsy hubs, weak poles and cheap fabric. The **QUICKFISH™** is the original and still the best. Constructed with sturdy hubs, strong poles, ample storage pockets, reinforced bottoms, YKK® zippers, IceTight™ fabric, self-tapping ice anchors and removable windows. The QuickFish is built to last season after season.

QUICKFISH™ 2

SPECIFICATIONS **69151**

Capacity	2 People
Set-Up Size	60" x 60"
Elbow Room	76" x 76"
Fishable Area	25.0 sq. ft.
Height	67"
Collapsed Size	8.5" x 8.5" x 45"
Weight	18 lbs.
Warranty	1-Year Limited
Ice Anchors	6
Ventilation	2
Windows	4
Doors	1
Mesh Pockets	1
Fabric	300D IceTight
Transport	Cinch Backpack



QUICKFISH™ 3

SPECIFICATIONS **69143**

Capacity	3 People
Set-Up Size	70" x 70"
Elbow Room	90" x 90"
Fishable Area	34.0 sq. ft.
Height	80"
Collapsed Size	8.5" x 8.5" x 52"
Weight	23 lbs.
Warranty	1-Year Limited
Ice Anchors	6
Ventilation	2
Windows	4
Doors	2
Mesh Pockets	2
Fabric	300D IceTight
Transport	Cinch Backpack





REMOVABLE WINDOWS



YKK ZIPPERS



PORTABLE

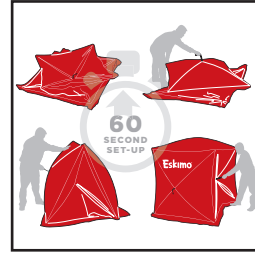

60 SECOND SET-UP



IQ™ INSULATED FABRIC
(69445 MODEL ONLY)

QUICKFISH™ 3i



SPECIFICATIONS

69445

Capacity	3 People
Set-Up Size	70" x 70"
Elbow Room	90" x 90"
Fishable Area	34.0 sq. ft.
Height	80"
Collapsed Size	10.5" x 10.5" x 52"
Weight	34 lbs.
Warranty	1-Year Limited
Ice Anchors	6
Ventilation	2
Windows	4
Doors	2
Mesh Pockets	2
Fabric	Insulated IQ
Transport	Cinch Backpack

SPECIFICATIONS

69149

Capacity	6 People
Set-Up Size	70" x 140"
Elbow Room	90" x 160"
Fishable Area	68.0 sq. ft.
Height	80"
Collapsed Size	10.5" x 10.5" x 52"
Weight	38 lbs.
Warranty	1-Year Limited
Ice Anchors	9
Ventilation	2
Windows	6
Doors	2
Mesh Pockets	2
Fabric	300D IceTight
Transport	Cinch Backpack

QUICKFISH™ 6



INFERNO

FLIP SHELTERS



WIDE1™ INFERNO

The fully-insulated Eskimo **WIDE1™ INFERNO** is an expandable wide-bottom one-man flip-style shelter. Its patented design gives anglers more fishable space, while maintaining the lightweight portability of a one-man shelter thanks to a telescoping front end. Once the front end is expanded, users can fish multiple lines and still have room for electronics and a heater. A larger sled on the Wide1 Inferno creates more fishable area with 14.8 square feet and 60 inches of height for setting hooks.

FEATURES:

- Expandable front spreader bar – allowing for 32% more fishable area than any other shelter in its class
- Double-walled hinge provides a sturdier structure in windy conditions
- Mesh storage pockets help to keep your essential fishing gear handy
- Easy to flip up and use as a windbreak on sunny days

SPECIFICATIONS

15350

Capacity	1 Person
Set-Up Size	97" x 52"
Sled Size	10" x 32" x 50"
Fishable Area	14.8 sq. ft.
Height	60.5"
Collapsed Size	17" x 32" x 50"
Weight	62 lbs.
Warranty	1-Year Limited
Framework	Steel / Aluminum
Fabric	Insulated IQ
Transport	Towable
Seating	Swivel Versa Seat
Seat Height	18"
Seat Gear Nets	1
Ventilation	2
Windows	4
Doors	1
Mesh Pockets	2



FIRST EXPANDING WIDE-BOTTOM FLIP-STYLE SHELTER



QRS™ QUICK RELEASE SYSTEM



IQ™ INSULATED FABRIC

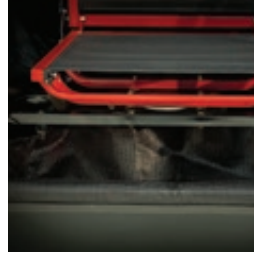

UNDERSEAT GEAR NETS (WIDE1)



DOUBLE-WALL HINGE (FLIPMO2)



SWIVEL VERSA SEAT(S)

FLIPMO² **INFERNO**

The **FLIPMO 2™ INFERNO** shelter is designed for guides and anglers who demand the best ice fishing shelter available. All these features are mounted on an oversized tub, giving anglers plenty of room for storage with leading class durability. This shelter offers all of the features that the most demanding guides and anglers want at a price that won't break the budget.

FEATURES:

- Three large built-in tables to set your gear on
- Large, under seat gear nets to keep your gear off the ice and out of bottom of the sled
- Built-in spreader poles allow for quick and easy storage
- Mesh storage pockets help to keep your essential fishing gear handy
- Easy to flip up and use as a windbreak on sunny days

SPECIFICATIONS

15450

Capacity	2 People
Set-Up Size	72" x 93"
Sled Size	11" x 36" x 72"
Fishable Area	29.0 sq. ft.
Height	74.5"
Collapsed Size	23" x 36" x 72"
Weight	117 lbs.
Warranty	1-Year Limited
Framework	Steel / Aluminum
Fabric	Insulated IQ
Transport	Towable
Seating	(2) Swivel Versa Seats
Seat Height	18"
Seat Gear Nets	2
Ventilation	2
Windows	6
Doors	1
Mesh Pockets	2



MORE ROOM, STRONGER FRAME, SWIVEL SEATS

QUICKFLIP FLIP SHELTERS



QUICKFLIP¹

With the Eskimo® **QUICKFLIP™ 1**, you can get down to the business of ice fishing quickly with the easy-to-set-up flip design. This one-man shelter is the easiest and most transportable shelter on the market today. The included folding ice chair is lightweight and can be used inside or outside the shelter.

“*The QuickFlip is perfect for a day of running and gunning in search of active fish.*”

SCOTTY BREWER
BREWER-AGRE OUTDOORS

FEATURES:

- **LIGHTWEIGHT** – Weighing only 47 pounds, the QuickFlip 1 is lighter than comparable one-man shelters on the market
- **TOWABLE** – The QuickFlip 1 attaches to your snowmobile or ATV for towing (tow bar not included)
- **REMOVABLE WINDOWS** – Adjust your shelter’s ventilation with detachable hook and loop windows
- **PORTABLE** – Pull-rope included for easy portability
- **WINDBREAK MODE** – Easy to flip up and use as a windbreak on sunny days

SPECIFICATIONS

15300

Capacity	1 Person
Set-Up Size	32" x 96"
Sled Size	10" x 32" x 50"
Fishable Area	9.3 sq. ft.
Height	60.5"
Collapsed Size	17" x 32" x 50"
Weight	47 lbs.
Warranty	1-Year Limited
Framework	Steel
Fabric	300D IceTight™
Transport	Towable
Seating	Folding Ice Chair
Seat Height	16.5"
Ventilation	2
Windows	3
Doors	1
Mesh Pockets	2



FOLDING CHAIR INCLUDED

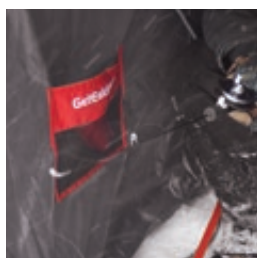

MESH STORAGE POCKETS



DOUBLE-WALL HINGE



YKK® ZIPPERS



WINDBREAK MODE



UNIVERSAL TOW HITCH AVAILABLE SEPARATELY (11608)

QUICKFLIP 2™

The **QUICKFLIP™ 2** is a comfortable and economical shelter. Its proven time-tested design has been a reliable choice for ice anglers for years. The redesigned Eskimo Versa Top seat offers anglers a premium seat at an affordable price. The shelter gives the best value for the dollar and high-quality engineering at an affordable price.

FEATURES:

- **TOWABLE** – The QuickFlip 2 attaches to your snowmobile or ATV for towing (tow bar not included)
- **REMOVABLE WINDOWS** – Adjust your shelter’s ventilation with detachable hook and loop windows
- **PORTABLE** – Pull-rope included for easy portability
- **WINDBREAK MODE** – Easy to flip up and use as a windbreak on sunny days

SPECIFICATIONS

15400

Capacity	2 People
Set-Up Size	60" x 84"
Sled Size	7" x 31.5" x 60"
Fishable Area	22.5 sq. ft.
Height	67"
Collapsed Size	19.5" x 36" x 60"
Weight	87 lbs.
Warranty	1-Year Limited
Framework	Steel
Fabric	300D IceTight
Transport	Towable
Seating	(2) Fixed Versa Seats
Seat Height	18"
Ventilation	2
Windows	4
Doors	1
Mesh Pockets	2



DUAL SWIVEL SEATING



Eskimo is a group of dedicated & talented individuals who have an innovative vision and a real passion for serving their customers and community!"

KYLE AGRE
BREWER-AGRE OUTDOORS

INNOVATION
BUILDING SHELTERS

50 YEARS
BUILDING AUGERS



Eskimo[®]
ICE FISHING GEAR



MORE ICE FISHERMEN CHOOSE ESKIMO® THAN ANY OTHER BRAND.

“ *For the money, you cannot buy another shelter as nice. I would recommend Eskimo to anyone.*”

JOHN L.
ESKIMO CUSTOMER

“ *We're on the ice all winter, and we know we can trust Eskimo's gear to perform effortlessly in all situations. Their reliability allows us to keep the focus on catching fish.*”

MIKE OLSON
FISHADDICTIONS.COM

“ *I have had an early model Eskimo auger for over 25 years, and I've never had a mechanical issue with it. Buy an Eskimo and you should never have to buy another auger.*”

AARON M.
ESKIMO CUSTOMER



VISIT OUR WEBSITE TO SEE
HANDS-ON PRODUCT VIDEOS

WWW.GETESKIMO.COM

ESKIMO®

POWER AUGERS

WHY ESKIMO?

THINGS TO CONSIDER
WHEN CHOOSING AN AUGER

#1 IN
POWER
AUGERS

*DURABILITY AND
RELIABILITY COME
STANDARD WITH
EVERY AUGER
WE MAKE*



FEATURING

VIPER®
ENGINES

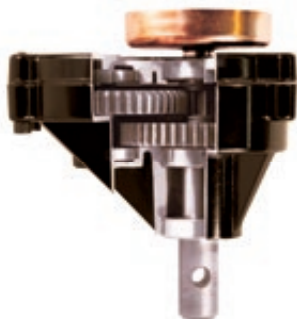

ALL-METAL TRANSMISSION

All Eskimo power augers feature a precision transmission made of all-metal, without any plastic pieces. This gives you more durability, power, and control from your powerhead.



MITTEN GRIP RECOIL

LARGE HANDLE STARTUP

Oversized mitten grip handles make starting your Eskimo auger a breeze. The large plastic handle accommodates your hand without requiring you to take off your gloves or mitts, meaning you can stay warm and bundled up while drilling.

QUANTUM CUTTING SYSTEM

PERFECT FOR RE-DRILLING OLD HOLES

All Eskimo power augers feature the Quantum™ Cutting System. The Quantum system is specially designed with a unique centering ring that allows you to re-drill old holes by metering the cutting depth with each revolution. Quantum blades last longer than competitor blades and hold their edge well in dirty ice. The combined centering ring and Quantum blades make this cutting system a versatile way to tackle whatever ice you face—whether it's a mess of slush or a clean sheet. Whether your auger is gas or propane, the Quantum Cutting System will deliver.



TRUSTED DURABILITY

INDUSTRY-LEADING 2-YEAR WARRANTY

Eskimo crafts all of their ice fishing gear with durability in mind, and augers are no different. Eskimo augers are built to last from season to season, with helpful customer service available year-round for any issues that do arise. Eskimo stands behind their line of power augers with an industry-leading 2-year warranty.

“Propane is the way to go. No gas fumes or having to deal with a gas can.”

MARK L.
ESKIMO HC40 CUSTOMER

“I have drilled about 60-70 holes with it and I am still on the first tank of propane”

PETE M.
ESKIMO HC40 CUSTOMER



PROPANE POWER AUGERS

HC40



“ No fuel mixing or spilling. No priming or choking. No hassle. I love the HC40 and know anyone who gets their hands on one will too.”

MIKE OLSON
FISHADDICTIONS.COM

**HIGH COMPRESSION
HARDER EXPLOSIONS = MORE POWER**

The Eskimo® **HC40** weighs as little as 30lbs. and has an engine specifically designed to take full advantage of the higher octane rating of propane fuel. Many ice anglers are switching to 4-cycle propane powered augers because they are clean burning and low-maintenance.

The HC40 gives ice anglers the reliability and dependability they have come to expect from Eskimo in an extremely powerful, lightweight package.

FEATURES:

- **HIGH COMPRESSION ENGINE** – A clean burning, 40cc 4-cycle engine with minimal emissions, specifically designed for high-octane propane fuel. The engine is paired with a precision transmission which offers optimum gearing. Both of these mean more power output for your auger.
- **EASY TO USE, EASY TO STORE** – The HC40 is a low maintenance unit. It's light, portable, and easy to transport in your sled or vehicle.
- **FUEL SYSTEM** – An auto prime fuel system and high-profile on/off switch make startup quick, easy, and reliable. Runs on readily available 1lb. propane cylinder, and easily connects with a Quick-Release bottle holder.
- **QUANTUM CUTTING SYSTEM** – The Quantum Auger and Quantum Blades last longer and hold their edge in dirty ice.



SEE THE
PROPANE HC40
IN ACTION AT
GETESKIMO.COM



“ Starts the first time every time...it's a breeze making those 10 inch holes.”

GLORIA A.
ESKIMO HC40 CUSTOMER

HIGH-COMPRESSION PROPANE AUGER



MITTEN GRIP
RECOIL



QUICK, EASY
ON/OFF SWITCH



QUICK RELEASE
BOTTLE HOLDER



LOW MAINTENANCE
PORTABILITY



QUANTUM™
BLADES

SPECIFICATIONS

HC40Q8

Engine	High-Compression 4-Cycle
Displacement	40.0cc
Gear Ratio	30:1
Transmission	Ball Bearing, Alloy Gear
Weight	30 lbs.
Warranty	2-Year Limited
Auger Length	42"
Cutting Diameter	8"
Blade Style	Quantum
Handle Design	Foam Grip
Starter Handle	Mitten Grip

SPECIFICATIONS

HC40Q10

Engine	High-Compression 4-Cycle
Displacement	40.0cc
Gear Ratio	49:1
Transmission	Ball Bearing, Alloy Gear
Weight	33 lbs.
Warranty	2-Year Limited
Auger Length	42"
Cutting Diameter	10"
Blade Style	Quantum
Handle Design	Foam Grip
Starter Handle	Mitten Grip



40cc

8"
AUGER



40cc

10"
AUGER

STINGRAY

POWER AUGERS

STINGRAY™
S33



FOAM GRIP
HANDLES



SEE-THROUGH
GAS TANK



MUFFLER GUARD

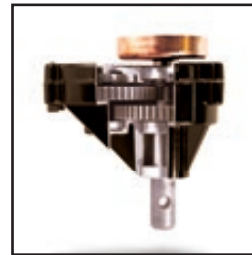

PRECISION
TRANSMISSION



QUANTUM™ BLADES

“Great lightweight yet powerful machine. Easiest starting and quietest running 2-cycle engine I’ve ever owned.”
JAMES W. ESKIMO STINGRAY CUSTOMER

The Eskimo® **STINGRAY** has all of the features you need in an ice auger while being easy on the wallet. It is rugged, dependable, lightweight, has fast-cutting Quantum Blades, and is powered by a reliable 33cc Viper® engine that starts in the coldest of weather.

FEATURES:

- Wide-wing tubular steel handle bars
- Finger tip throttle trigger for precise power control
- Weighs only 28lbs.

VIPER®
ENGINES

33cc

8"
AUGER



SPECIFICATIONS

S33Q8

Engine	Viper 2-Cycle
Displacement	33.0cc
Engine RPM	9000
Gear Ratio	49:1
Transmission	All Ball Bearing
Weight	28 lbs.
Warranty	2-Year Limited
Auger Length	42"
Cutting Diameter	8"
Blade Style	Quantum
Handle Design	Foam Grip
Starter Handle	Mitten Grip

LIGHTWEIGHT AND RELIABLE

MAKO

POWER AUGERS

MAKO™
M43



HIGH-PROFILE
ON/OFF SWITCH



MUFFLER GUARD

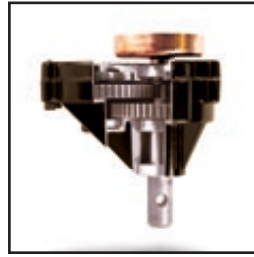

PRECISION
TRANSMISSION



QUANTUM™ BLADES

“ I’m on my fourth year with my Mako M43 and it runs like a champ.”
JEFFREY T. ESKIMO MAKO CUSTOMER

The **MAKO** offers many of the features found on high-end augers, but in a more economical package. With the Eskimo Quantum blades, the original cold-weather Viper engine, and features like a mitten-grip recoil, you’ll have a cost-effective, easy-to-use ice auger that will perform year after year.

FEATURES:

- See-through gas tank for easy fuel level detection
- Finger tip throttle trigger for precise power control

SPECIFICATIONS **M43Q8 / M43Q10**

Engine	Viper 2-Cycle
Displacement	43.0cc
Engine RPM	9000
Gear Ratio	30:1
Transmission	All Ball Bearing
Weight	32 lbs. / 34 lbs.
Warranty	2-Year Limited
Auger Length	42"
Cutting Diameter	8" / 10"
Blade Style	Quantum
Handle Design	Foam Grip
Starter Handle	Mitten Grip

VIPER®
ENGINES

43cc

AVAILABLE

8"
AUGER

10"
AUGER



STYLE AND PERFORMANCE

SHARK

POWER AUGERS



SHARK™ Z51

A SIMPLY UNSTOPPABLE ICE AUGER

The **SHARK Z51** has a 51.7cc two-cycle engine that gives the strength expected of a Viper® engine. It is quick and easy to control so you'll spend less time drilling and more time fishing.

SHARK™ Z71

THE MOST POWERFUL ICE AUGER IN THE WORLD

The **SHARK Z71** is the most powerful ice auger in the world. It features a 71cc Viper two-cycle engine specially designed for ice augers. With high torque and RPM, you'll have a Viper engine that overpowers the competition but remains easy to start and operate.

FEATURES:

- **INDUSTRY-FIRST HYPERCOIL™**
Recoil technology that reduces required pulling force by up to 62%, resulting in easier starts and reduced stress on your arms and shoulders.
- **INDUSTRY-FIRST ALUMINUM HANDLE BARS**
Eskimo aluminum handle bars are designed with 45 degree rubber-coated grips that allow ideal wrist motion when drilling a hole. The throttle control is canted in 45 degrees, giving you comfortable control and the ability to easily pull the auger out of the ice without accidentally revving the engine.



Awesome auger. Started on the first pull right out of the box. Cuts nice holes fast and is very easy to run."

FRANK K.
ESKIMO SHARK CUSTOMER



SEE THE
SHARK AUGERS
IN ACTION AT
GETESKIMO.COM





PRECISION TRANSMISSION



HIGH-PROFILE ON/OFF SWITCH

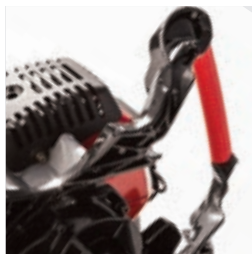

INDUSTRY-FIRST ALUMINUM HANDLE



INDUSTRY-FIRST HYPERCOIL



QUANTUM™ BLADES

SPECIFICATIONS

Z51Q8 / Z51Q10

Engine	Viper 2-Cycle
Displacement	51.7cc
Engine RPM	9000
Gear Ratio	25:1
Transmission	All Ball Bearing
Weight	32 lbs. / 33 lbs.
Warranty	2-Year Limited
Auger Length	42"
Cutting Diameter	8" / 10"
Blade Style	Quantum
Handle Design	Aluminum with Comfort Grip
Starter Handle	Mitten Grip

SPECIFICATIONS

Z71Q10

Engine	Viper 2-Cycle
Displacement	71.0cc
Engine RPM	9000
Gear Ratio	25:1
Transmission	All Ball Bearing
Weight	34 lbs.
Warranty	2-Year Limited
Auger Length	42"
Cutting Diameter	10"
Blade Style	Quantum
Handle Design	Aluminum with Comfort Grip
Starter Handle	Mitten Grip

VIPER
ENGINES

51.7cc

AVAILABLE

8"
AUGER

10"
AUGER



VIPER
ENGINES

71cc

10"
AUGER



HAND AUGERS



Silvertip[™] HAND AUGER

The Eskimo **SILVERTIP[™]** hand auger takes the work out of ice fishing. The CNC ground curved blades put the cutting edge of the Silvertip in precisely the right position for easy and effective cutting. As a result, Silvertip augers tunnel through the ice, requiring minimal down force. Just turn the handle, and let this beautifully designed auger do the rest.



ESKIMO[®] HAND AUGER

Eskimo hand augers are a perfect travel companion for early-or-late-season ice anglers. They are lightweight and effortlessly cut through the ice. Eskimo hand ice auger blades are flat and are designed for long life.



SPECIFICATIONS

16000 / 16500

Auger Length	49" - 58" (Adjustable)
Cutting Diameter	6" / 8"
Blade Style	Curved Blades
Handle Design	2-Piece Pommel
Weight	7 lbs. / 8 lbs.
Warranty	1-Year Limited

The Silvertip blades are formed from a high carbon martensitic stainless steel used most often for knife blades. The hardness and wear resistance of the Silvertip blades are further enhanced by post forming heat treatment. All the work that we put into designing the new Silvertip auger results in less effort when you're out on the ice.

SPECIFICATIONS

HD06 / HD07 / HD08

Auger Length	49" - 58" (Adjustable)
Cutting Diameter	6" / 7" / 8"
Blade Style	Dual-Flat Blades
Handle Design	2-Piece Pommel
Weight	6.5 lbs. / 7 lbs. / 7.5 lbs.
Warranty	1-Year Limited

HAND AUGER REPLACEMENT BLADES

6"	Hand Auger Blades	RB6
7"	Hand Auger Blades	RB7
8"	Hand Auger Blades	RB8
6"	Silvertip [™] Hand Auger Blades	15850
8"	Silvertip [™] Hand Auger Blades	15870

ICE CHISELS



REDNECK CHISELS™



TRIPLE-ACTION HEAD

A multi-faceted, triple-action chipper head increases surface area and focuses power to sharp points, allowing you to chip more with fewer strokes.



CH7

CH9

CH10

CH11

CH12



FOAM COMFORT GRIP

Foam-grip, anti-vibration handle adds comfort while the tether rope keeps the chisel secure around your wrist.

Long-lasting. Durable. Comfortable. When it comes to **REDNECK CHISELS**, those words say it best. Our heavy-duty line of chisels have everything you need to effectively chip through the ice. The Redneck Chisels are a rock-solid tool perfect for cutting out or re-opening a hole early or late in the season. They're a must-have addition to your ice fishing gear.

SPECIFICATIONS

CH7	Economy Chisel	52.5"	4.5 lbs.	Single-Action	Bare Handle
CH9	Bucket Chisel	19.0"	4.0 lbs.	Dual-Action	Bare Handle w/Tether
CH10	Short Chisel	25.5"	3.0 lbs.	Triple-Action	Foam Grip w/Tether
CH11	One-Piece Chisel	59.5"	11.0 lbs.	Triple-Action	Foam Grip w/Tether
CH12	Two-Piece Chisel	64.0"	11.0 lbs.	Triple-Action	Foam Grip w/Tether

LAKE RUNNER

LAKE RUNNER™ BY ESKIMO®



SEE THE
LAKERUNNER
IN ACTION AT
GETESKIMO.COM

FRAME FITS:

15450	FlipMo2
11597	FlipMo3
69168	Quickflip3

INCLUDES EVERYTHING SHOWN ABOVE: Tub / Frame / Adjustable Tow Bar / Runner Kit

The **LAKE RUNNER** from Eskimo is the first towable-utility hauler designed for rough-winter terrain. Today's plastic sleds can easily crack when encountering ice chunks or often face plowing issues due to design flaws. The Lake Runner gives you ground clearance unlike any other, 6" of lift gets your gear off the ground and provides stability in transport.

The unique design of the Lake Runner gives you the option to lower the sled to the ground for easy loading/unloading. The innovative lever design lifts the sled and contents inside (300lb weight rating) from the ground. A traveling weight of 900lbs is allowed when lever is not being used to lift the load. Lake Runner takes the hassles out of winter towing.

SPECIFICATIONS

15575

Lift Capacity	300 lbs.
Travel Capacity	900 lbs.
Tub Dimensions	35.5" x 71.75"
Height	20.5" (up) 14.5" (down)
Weight	144 lbs.
Framework	Steel Tubing
Warranty	1-Year Limited



CLOTHING



ESKIMO HOODIES

19060	Eskimo Hockey Hoodie	S
19061	Eskimo Hockey Hoodie	M
19062	Eskimo Hockey Hoodie	L
19063	Eskimo Hockey Hoodie	XL
19064	Eskimo Hockey Hoodie	2XL



23051



19050



HG899 – HG901



68888



23050

ESKIMO HATS

HG899	Eskimo Alaskan Fur Hat	M
HG900	Eskimo Alaskan Fur Hat	L
HG901	Eskimo Alaskan Fur Hat	XL
19050	Eskimo Throw-Back Stocking Cap	One Size Fits All
23050	Eskimo Striped Winter Hat	One Size Fits All
23051	Eskimo Buffalo Cap	One Size Fits All
68888	Eskimo Pro Staff Hat	One Size Fits All



ACCESSORIES

ESKIMO® VIPER ENGINE OIL

300400

Viper® Oil 2-Cycle 50:1 (Single Pack)



ESKIMO 4-CYCLE ENGINE OIL

20427

0W-40 Engine Oil for 4-Cycle engines (propane) (Single Pack)



VIPER 2-CYCLE TUNE-UP KIT

KITTU101 Stingray / Mako / Shark 51.7cc

KITTU102 Shark 71cc

- Oil
- Air Filter
- Fuel Filter
- Spark Plug



HYPERCOIL

12777

Fits Eskimo 2-Cycle Ice Augers and reduces pulling effort by 62%. Features Mitten Grip Handle.



QUANTUM™ BLADES

QB8 (8"), QB10 (10")

Replacement blades for Quantum augers



QUANTUM REPLACEMENT CENTERING POINT

90129

Replacement centering point



QUANTUM AUGER

QT8N (8"), QT10N (10")

Replacement augers for powered ice augers

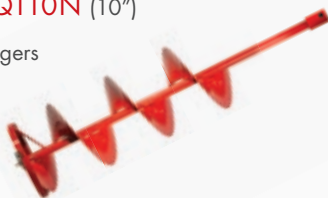

AUGER EXTENSION

EXT12 (12"), EXT18 (18")

Auger extension for powered ice augers

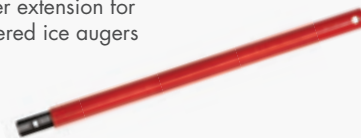

QUANTUM AUGER BLADE PROTECTOR

232A (8"), 233A (9", 10")

Quantum auger blade protector with bungee



ESKIMO VIPER SELF-VENTING GAS CAP

15346

Viper Self-Venting Gas Cap



ESKIMO REPLACEMENT STUB SHAFT

22045

Replacement stub shaft that connects the Quick Release System (16327) to an auger bit



ESKIMO ICE ANCHOR DRILL ADAPTER

18734

Universal ice anchor drill adapter



AUGER QUICK RELEASE SYSTEM

16327

The Eskimo Auger Quick Release allows you to quickly remove or attach your Eskimo Ice Auger Powerhead to your Eskimo Auger bit. This is a great way to switch between auger bit sizes or remove the auger for easy transport.



POWERHEAD AND ICE AUGER NOT INCLUDED. ASSEMBLY MAY BE REQUIRED



POWER AUGER BAG

69812

Power auger bag for Eskimo powered ice augers



POWERHEAD COVER

69811

Powerhead cover for Eskimo powered ice augers



RUNNER KIT

16465 Quickflip1 / Wide1 Inferno / EVO 1

69195 Quickflip2 / Eskape200/400 / EVO 2

69128 Quickflip3 / Flipmo2 Inferno / Eskape300



ICE ANCHORS

69138

2-Pack Eskimo ice anchors:

- Oversized grip
- Self-tapping
- Sharp point



UNIVERSAL SLED HITCH

11608



SHELTER TRAVEL COVERS

16475 Quickflip1 / Wide1 Inferno / EVO 1

69171 Quickflip2 / Eskape200/400

18950 Quickflip3 / Eskape300 / FlipMo2 Inferno

23400 EVO 2



VERSA CHAIR

11459

Durable folding chair



FOLDING ICE CHAIR

69813

Compact and versatile folding ice chair. These Eskimo chairs are designed tough with thicker steel poles, providing a comfortable place to sit while on the ice. The triangular design makes them perfect for jig fishing—a must have for the on-the-go ice fisherman.



2015-16 PRODUCT

POP-UP PORTABLE SHELTERS



Model	Part #	Capacity	Fishable Area	Set-Up Size	Elbow Room	Insulation	Height	Collapsed Size	Weight
Quickfish™ 2	69151	2	25.0 ft. ²	60" x 60"	76" x 76"	No	67"	45" x 8.5" x 8.5"	18 lbs.
Quickfish™ 3	69143	3	34.0 ft. ²	70" x 70"	90" x 90"	No	80"	52" x 8.5" x 8.5"	23 lbs.
Quickfish™ 3i	69445	3	34.0 ft. ²	70" x 70"	90" x 90"	Yes	80"	52" x 10.5" x 10.5"	28 lbs.
Quickfish™ 6	69149	6	68.0 ft. ²	140" x 70"	160" x 90"	No	80"	52" x 10.5" x 10.5"	38 lbs.
FatFish™ 767	FF767	2-3	40.0 ft. ²	76" x 76"	81" x 81"	No	67"	55" x 7.4" x 7.4"	23 lbs.
FatFish™ 949	FF949	3-4	61.0 ft. ²	94" x 94"	99" x 99"	No	80"	65" x 7.5" x 7.5"	27 lbs.
FatFish™ 949i	FF949i	3-4	61.0 ft. ²	94" x 94"	99" x 99"	Yes	80"	65" x 8.25" x 8.25"	34 lbs.
FatFish™ 6120	FF6120	5-7	80.0 ft. ²	115" x 115"	122" x 122"	No	78"	67" x 9" x 9"	36 lbs.
FatFish™ 6120i	FF6120i	5-7	80.0 ft. ²	115" x 115"	122" x 122"	Yes	76"	67" x 13" x 13"	52 lbs.
FatFish™ 9416	FF9416	7-9	109.0 ft. ²	167" x 94"	172" x 99"	No	80"	61" x 9.8" x 9.8"	41 lbs.
FatFish™ 9416i	FF9416i	7-9	109.0 ft. ²	167" x 94"	172" x 99"	Yes	80"	62" x 14" x 14"	55 lbs.

CROSSOVER SHELTERS



Model	Part #	Capacity	Fishable Area	Set-Up Size	Sled-Size	Insulation	Height	Collapsed Size	Weight
EVO™ 1	22100	1	19.5 ft. ²	66" x 92"	50" x 32" x 10"	No	65"	20.5" x 33.5" x 50"	52 lbs.
EVO™ 2	22200	2	34.25 ft. ²	105" x 105"	50" x 32" x 10"	No	75"	22.5" x 37.5" x 60"	85 lbs.

FLIP-STYLE SHELTERS



Model	Part #	Capacity	Fishable Area	Set-Up Size	Sled-Size	Insulation	Height	Collapsed Size	Weight
QuickFlip™ 1	15300	1	9.3 ft. ²	32" x 96"	50" x 32" x 10"	No	60.5"	50" x 32" x 17"	47 lbs.
Wide1™ Inferno	15350	1	14.8 ft. ²	85" x 51"	50" x 32" x 10"	Full	60.5"	50" x 32" x 17"	62 lbs.
QuickFlip™ 2	15400	2	22.5 ft. ²	84" x 60"	60" x 31.5" x 7"	No	67"	60" x 36" x 19.5"	87 lbs.
FlipMo™ 2 Inferno	15450	3	29.0 ft. ²	93" x 72"	72" x 36" x 11"	Full	74.5"	72" x 36" x 23"	117 lbs.

POWER ICE AUGERS



Model	Part #	Engine	CC's	Viper Engine RPM	Gear Ratio	Transmission	Auger Length
HC40™	HC40Q8	Viper®	40.0cc	9,500	30:1	All Ball Bearing	42"
HC40™	HC40Q10	Viper®	40.0cc	9,500	49:1	All Ball Bearing	42"
Stingray™	S33Q8	Viper®	33.0cc	9,000	49:1	All Ball Bearing	42"
Mako™	M43Q8	Viper®	43.0cc	9,000	30:1	All Ball Bearing	42"
Mako™	M43Q10	Viper®	43.0cc	9,000	30:1	All Ball Bearing	42"
Shark™	Z51Q8	Viper®	51.7cc	9,000	25:1	All Ball Bearing	42"
Shark™	Z51Q10	Viper®	51.7cc	9,000	25:1	All Ball Bearing	42"
Shark™	Z71Q10	Viper®	71.0cc	9,000	25:1	All Ball Bearing	42"

HAND ICE AUGERS



Model	Part #	Auger Length	Cutting Diameter	Blade Style	Handle Design	Weight	Warranty
Eskimo®	HD06	49" - 58"	6"	Straight Blades	2-piece Pommel	6.5 lbs.	1-year limited
Eskimo®	HD07	49" - 58"	7"	Straight Blades	2-piece Pommel	7.0 lbs.	1-year limited
Eskimo®	HD08	49" - 58"	8"	Straight Blades	2-piece Pommel	7.5 lbs.	1-year limited
Silvertip™	16000	49" - 58"	6"	Curved Blades	2-piece Pommel	7.0 lbs.	1-year limited
Silvertip™	16500	49" - 58"	8"	Curved Blades	2-piece Pommel	8.0 lbs.	1-year limited

REDNECK ICE CHISELS™



Model	Part #	Length	Head Design	Foam Grip	Tether	Weight	Head Protector
Economy Chisel	CH7	52.5"	Single Action	No	No	4.5 lbs.	No
Bucket Chisel	CH9	19"	Dual Action	No	Yes	4 lbs.	Yes (2)
Short Chisel	CH10	25.5"	Triple Action	Yes	Yes	3 lbs.	Yes
One-Piece Chisel	CH11	59.5"	Triple Action	Yes	Yes	11 lbs.	Yes
Two-Piece Chisel	CH12	64"	Triple Action	Yes	Yes	11 lbs.	Yes

SPECIFICATIONS

Transport	Framework	Fabric	Ice Anchor Qty.	Mesh Pockets	Ventilation	Windows	Doors	Gear Pockets	Warranty
Backpack	Hub-Style	300D	6	No	2	4	1	1	1-year limited
Backpack	Hub-Style	300D	6	No	2	4	2	2	1-year limited
Backpack	Hub-Style	Insulated IQ™	6	No	2	4	2	2	1-year limited
Backpack	Hub-Style	300D	9	No	2	6	2	2	1-year limited
Backpack	Hub-Style	300D	6	2	2	6 A-frame	2	2	1-year limited
Backpack	Hub-Style	300D	6	2	2	6 A-frame	2	2	1-year limited
Backpack	Hub-Style	Insulated IQ™	6	2	2	6 A-frame	2	2	1-year limited
Carry Bag	Hub-Style	300D	9	4	2	10 A-frame	2	2	1-year limited
Carry Bag	Hub-Style	Insulated IQ™	9	4	2	10 A-frame	2	2	1-year limited
Backpack	Hub-Style	300D	9	4	2	10 A-frame	2	4	1-year limited
Carry Bag	Hub-Style	Insulated IQ™	9	4	2	10 A-frame	2	4	1-year limited

Transport	Framework	Fabric	Seating	Seat Height	Ventilation	Windows	Doors	Gear Pockets	Warranty
Towable	Aluminum/Fiberglass	300D	Swivel Versa Seat	19"	1	5	1	2	1-year limited
Towable	Steel/Aluminum Fiberglass	300D	Swivel Versa Seat	19"	1	7	2	2	1-year limited

Transport	Framework	Fabric	Seating	Seat Height	Ventilation	Windows	Doors	Gear Pockets	Warranty
Towable	Steel/Aluminum	300D	Folding Ice Chair	16.5"	2	4	1	2	1-year limited
Towable	Steel/Aluminum	300D	Swivel Versa Seat	18"	2	4	1	2	1-year limited
Towable	Steel/Aluminum	300D	Fixed Versa Seat	18"	2	4	1	2	1-year limited
Towable	Steel/Aluminum	300D	Swivel Versa Seat	18"	2	6	1	2	1-year limited

Cutting Diameter	Blade Style	Handle Design	Starter Handle	Hypercoil	Weight	Warranty
8"	Quantum™	Tubular Steel with Foam	Mitten Grip	No	31 lbs.	2-year limited
10"	Quantum™	Tubular Steel with Foam	Mitten Grip	No	34 lbs.	2-year limited
8"	Quantum™	Tubular Steel with Foam Grip	Mitten Grip	No	28 lbs.	2-year limited
8"	Quantum™	Tubular Steel with Foam Grip	Mitten Grip	No	32 lbs.	2-year limited
10"	Quantum™	Tubular Steel with Foam Grip	Mitten Grip	No	34 lbs.	2-year limited
8"	Quantum™	Aluminum Handle Bar	Mitten Grip	Yes	32 lbs.	2-year limited
10"	Quantum™	Aluminum Handle Bar	Mitten Grip	Yes	33 lbs.	2-year limited
10"	Quantum™	Aluminum Handle Bar	Mitten Grip	Yes	34 lbs.	2-year limited



“My Eskimo shanty and auger are the best investments I have ever made into ice fishing.”

DONOVAN D.
ESKIMO CUSTOMER



VISIT GETESKIMO.COM TO
LEARN MORE ABOUT
INNOVATIVE ESKIMO GEAR,
AND TO SEE VIDEOS
OF PRODUCT IN ACTION

MORE ICE FISHERMEN CHOOSE ESKIMO® THAN ANY OTHER BRAND.

*Thank you for helping
make us the number
one brand in ice
fishing. Keep the
stories, pictures, and
videos coming!*



*Congratulations to our
2014-15
Gallery of Keepers
contest winner,
Dennis M. in Alaska*

WWW.GETESKIMO.COM

f /EskimoIceFishingGear **t** @Eskimo_IceGear **YouTube** EskimoIceFishingGear

Eskimo
ICE FISHING GEAR

Eskimo®, Division of Ardisam, Inc.

1160 8th Avenue, PO Box 666 • Cumberland, WI 54829
PHONE: 800.345.6007 • FAX: 715.822.2223 • EMAIL: info@geteskimo.com

22917
©2015 ARDISAM, INC.
ALL RIGHTS RESERVED